

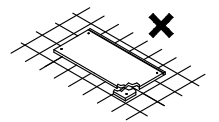

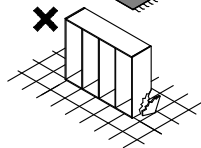

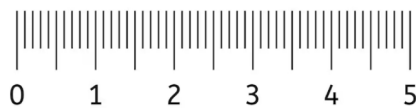

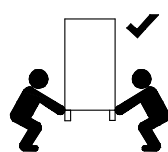

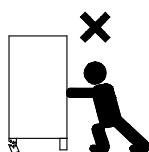
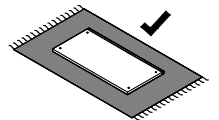
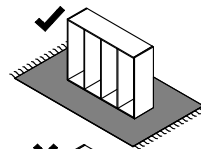
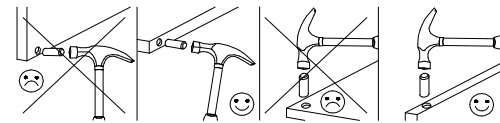
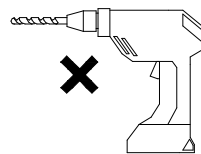
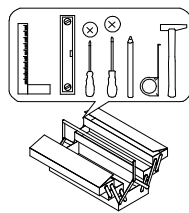
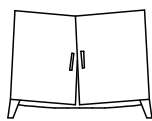
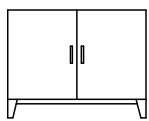
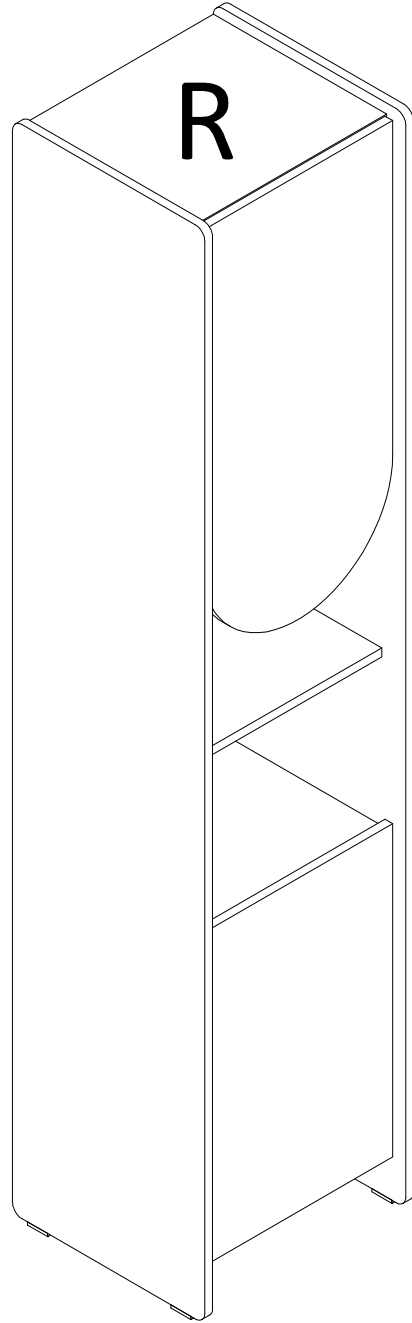
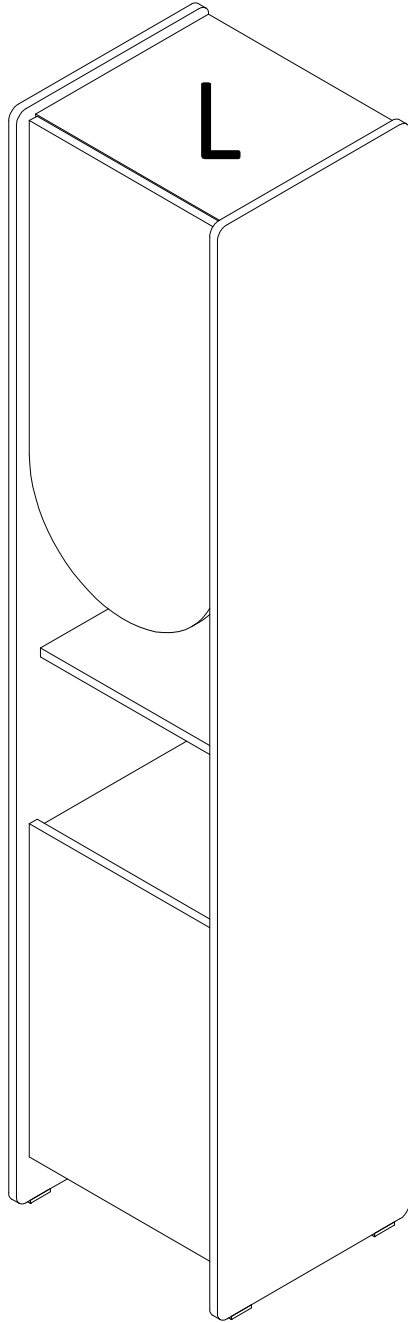
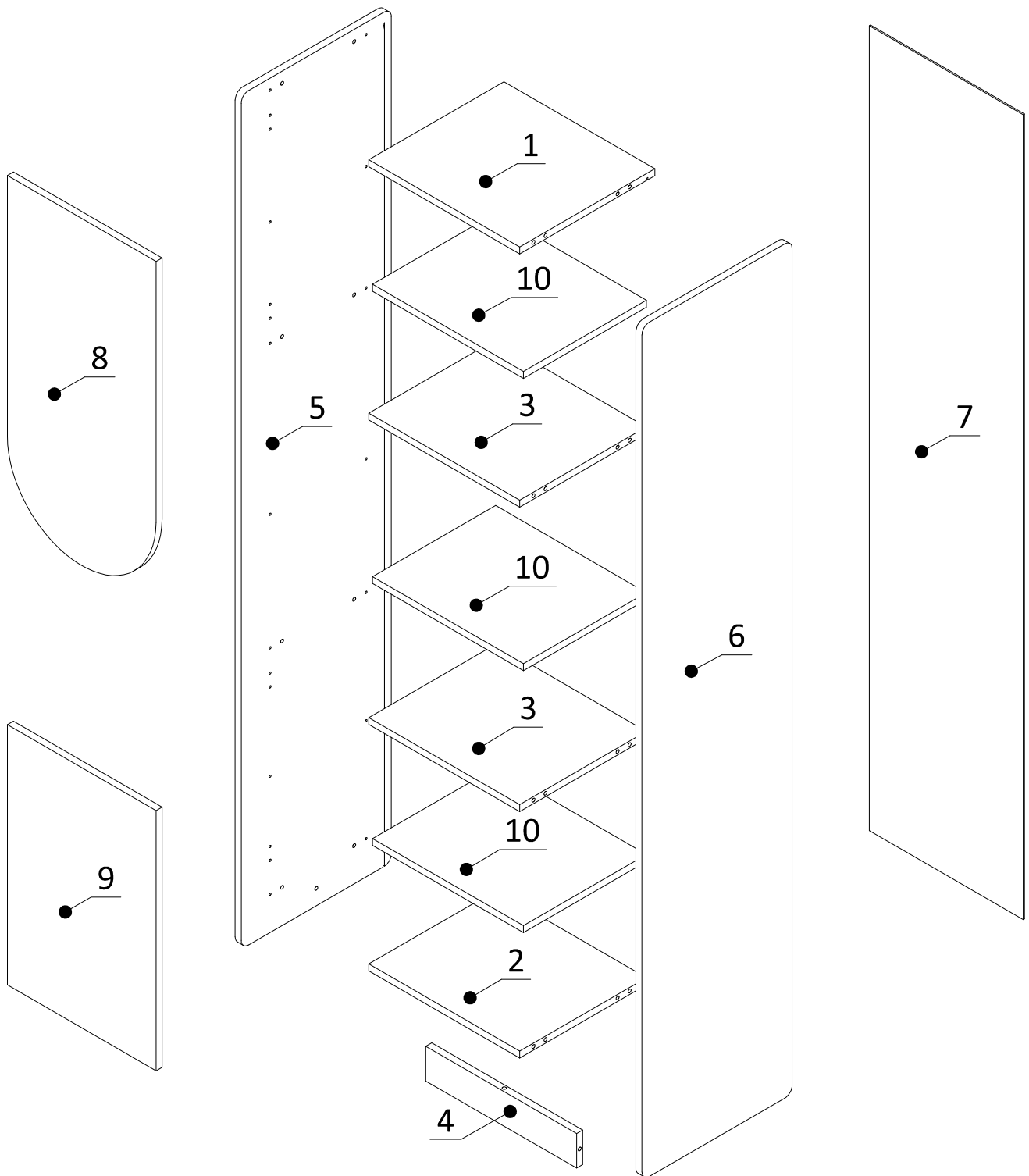
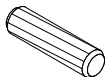

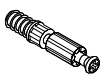

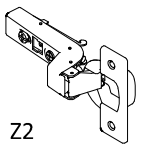
LEXI R-5



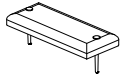



8x30 	15/12 	L20,3 
K	M	T

19x	16x	16x
4x16 	Z2 	PZ 
W4	Z2	PZ

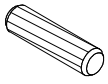

SL 	P 	ZM 	Z5 	G 	S 	PS 
4x	12x	16x	8x	12x	7x	1x

1

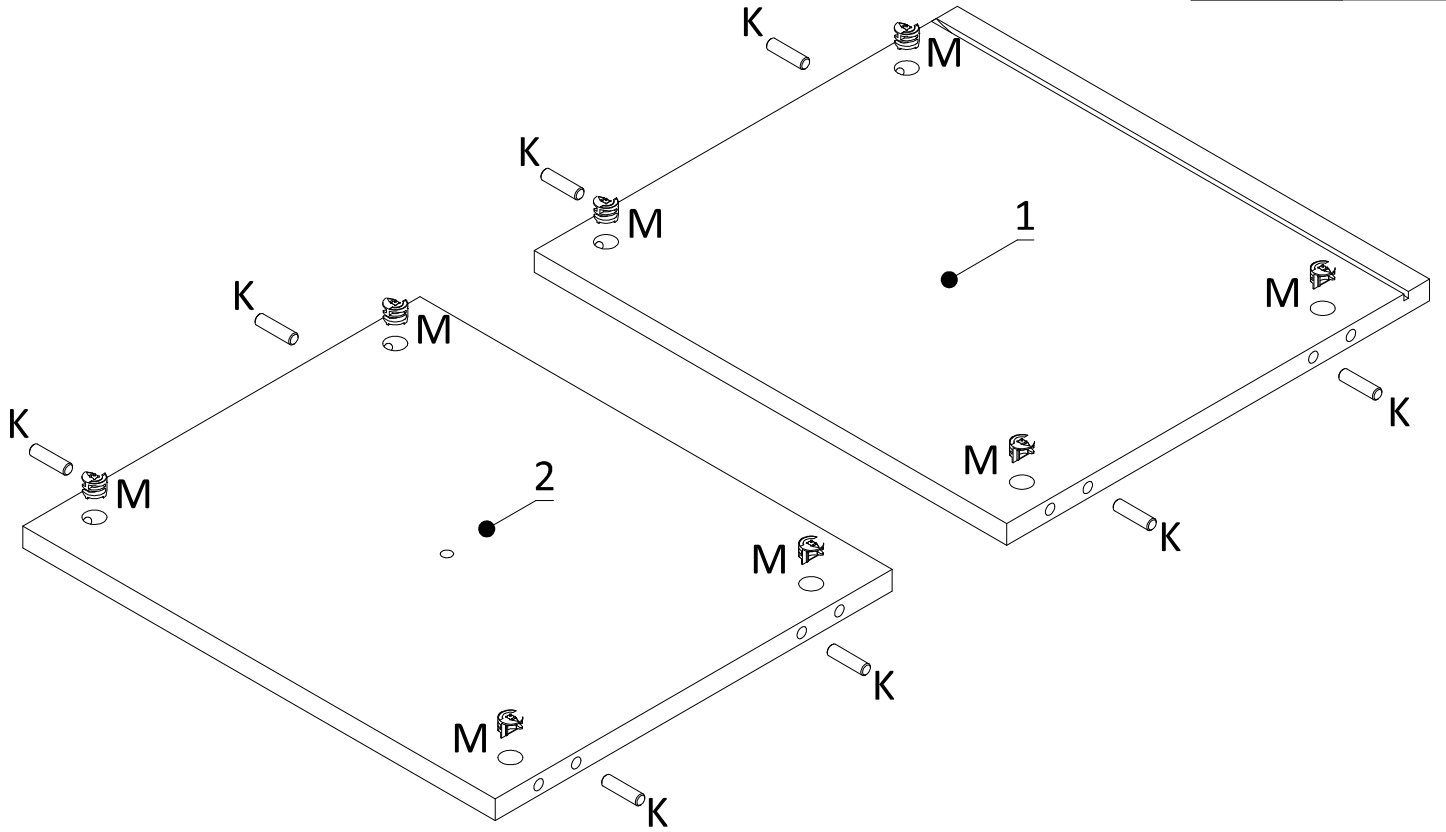
	
K	M
8x	8x

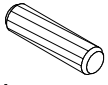

2

	
K	M
1x	8x

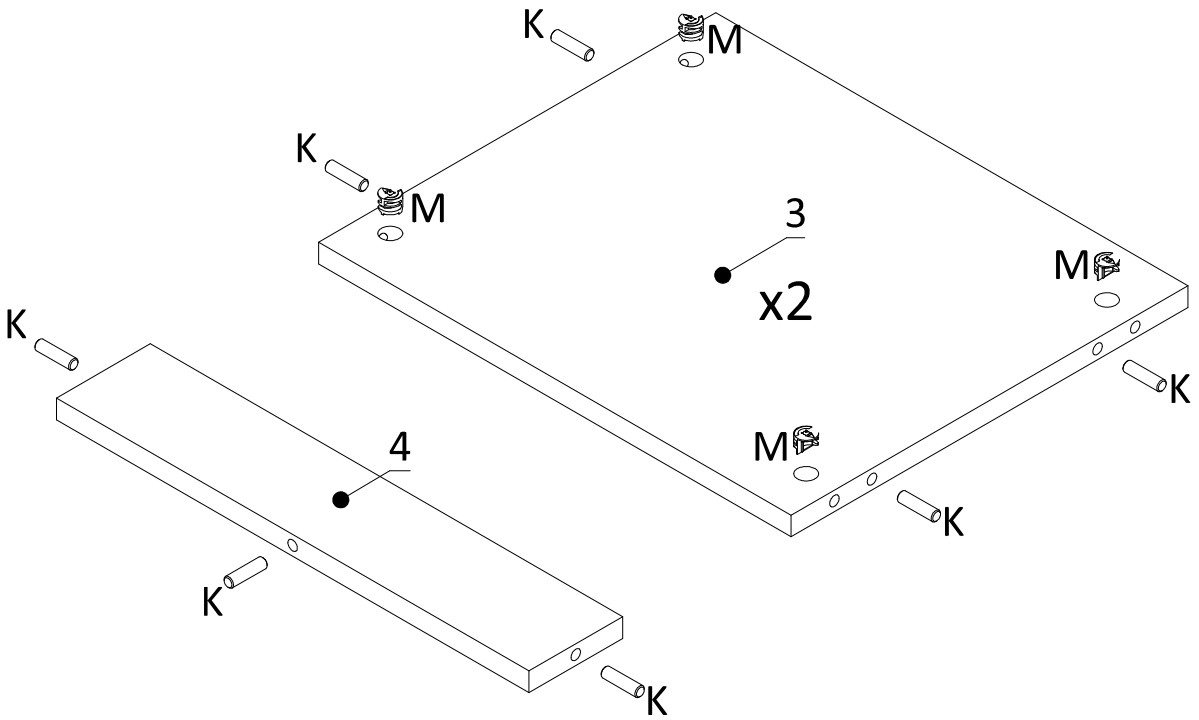

3

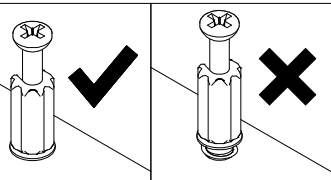
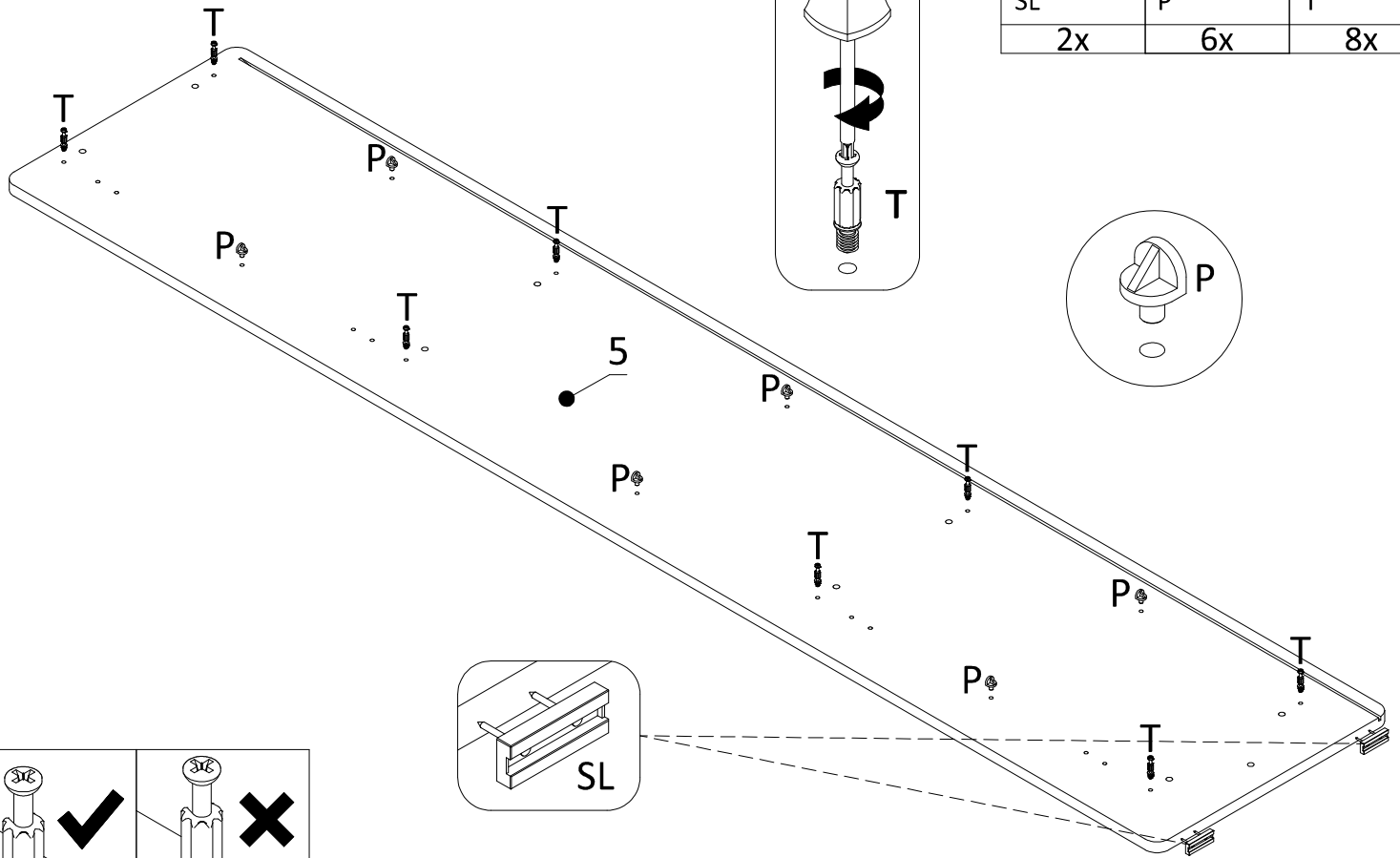

4

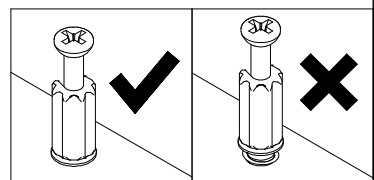
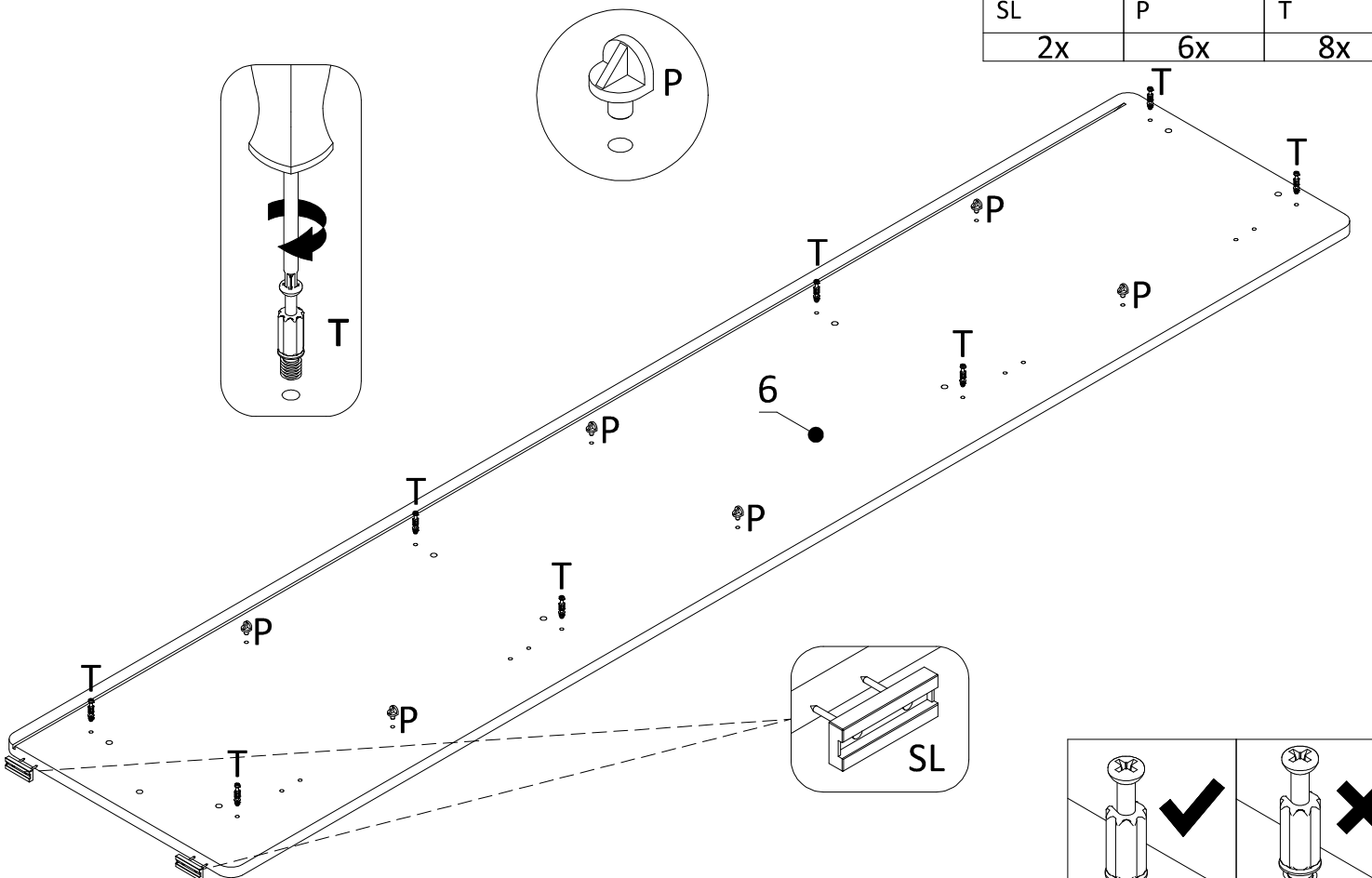

5 Option L

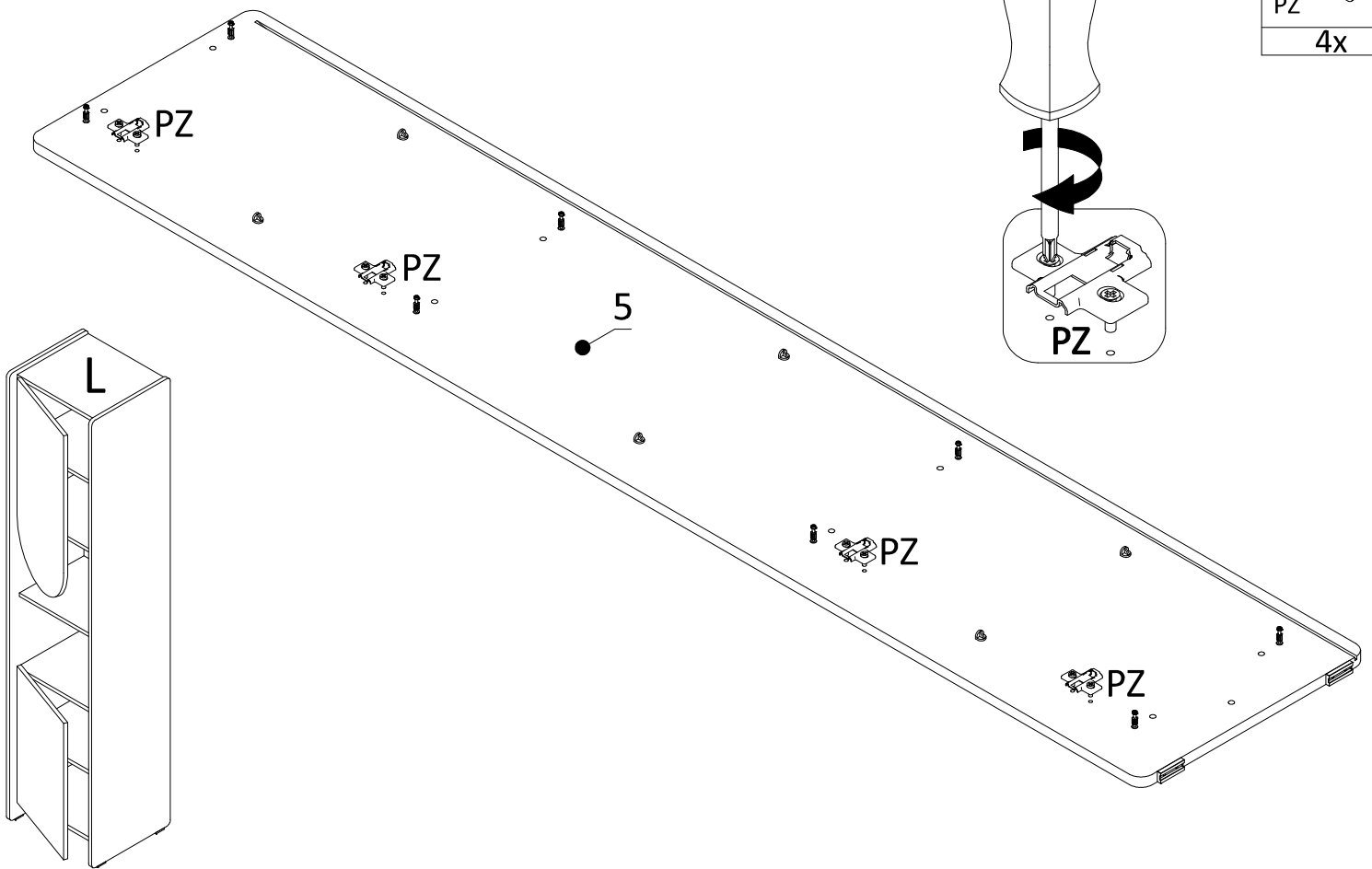

5 Option R

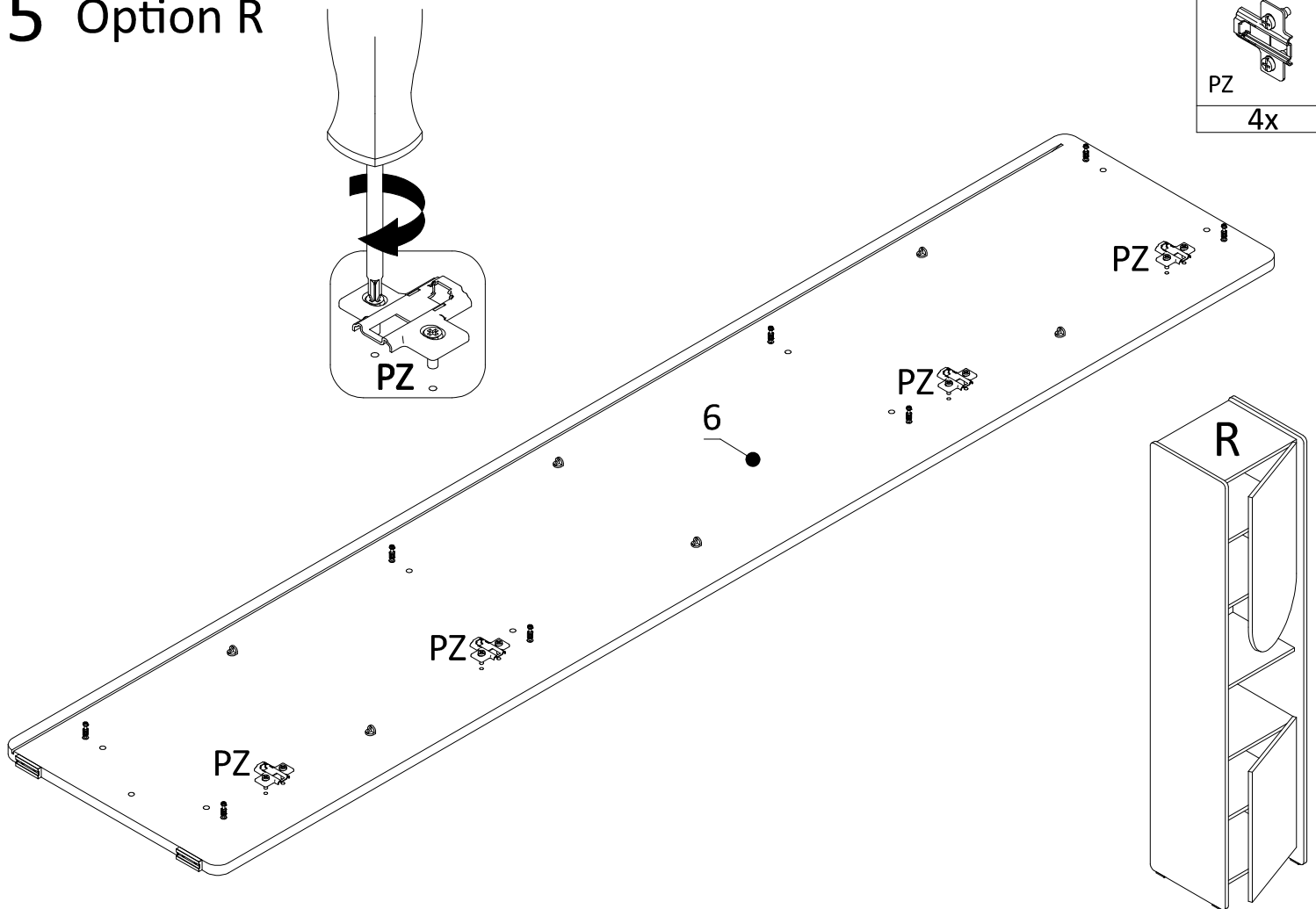

6 Option L

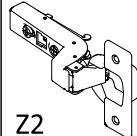
	
W4	Z2
4x	2x

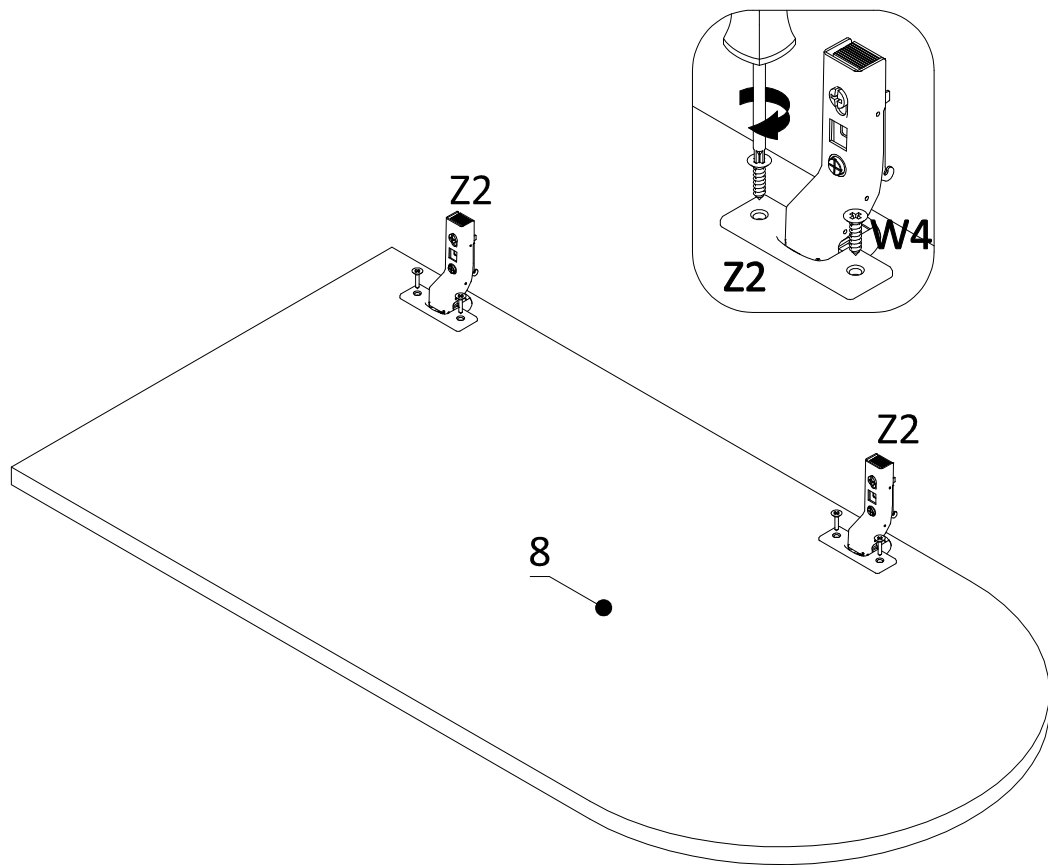

6 Option R

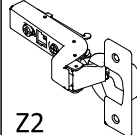
	
W4	Z2
4x	2x

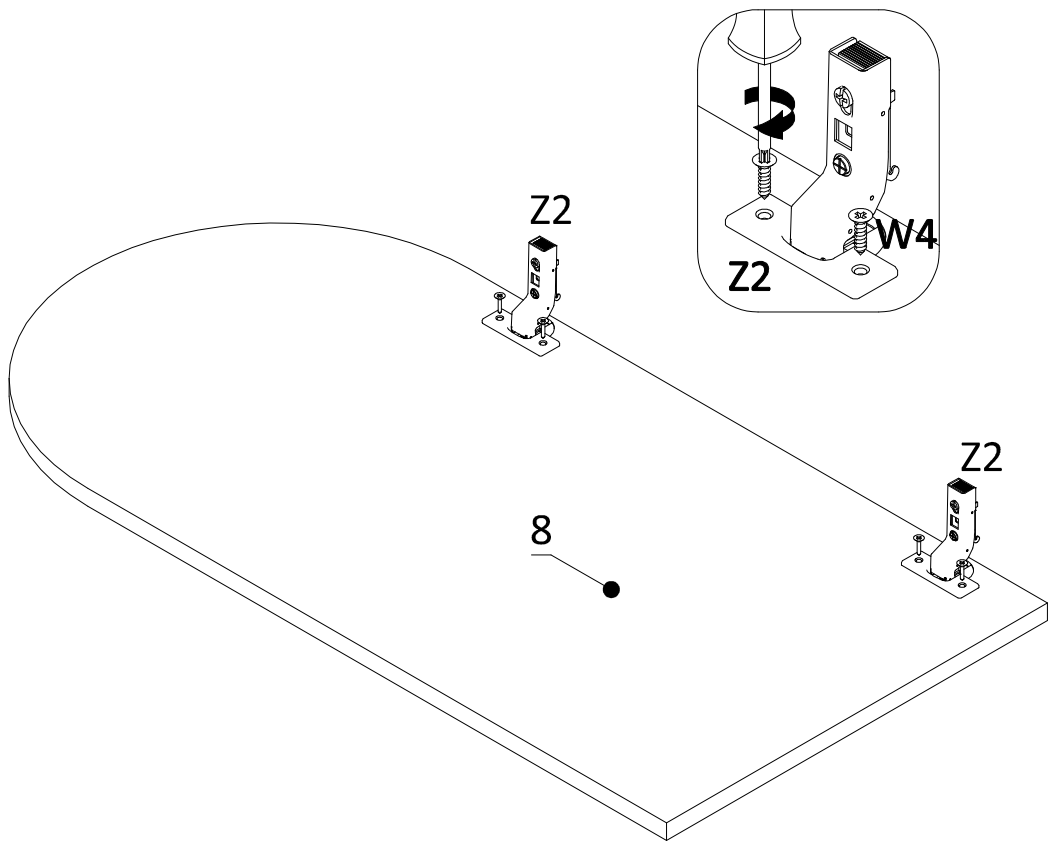

7

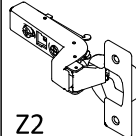
	
W4	Z2
4x	2x

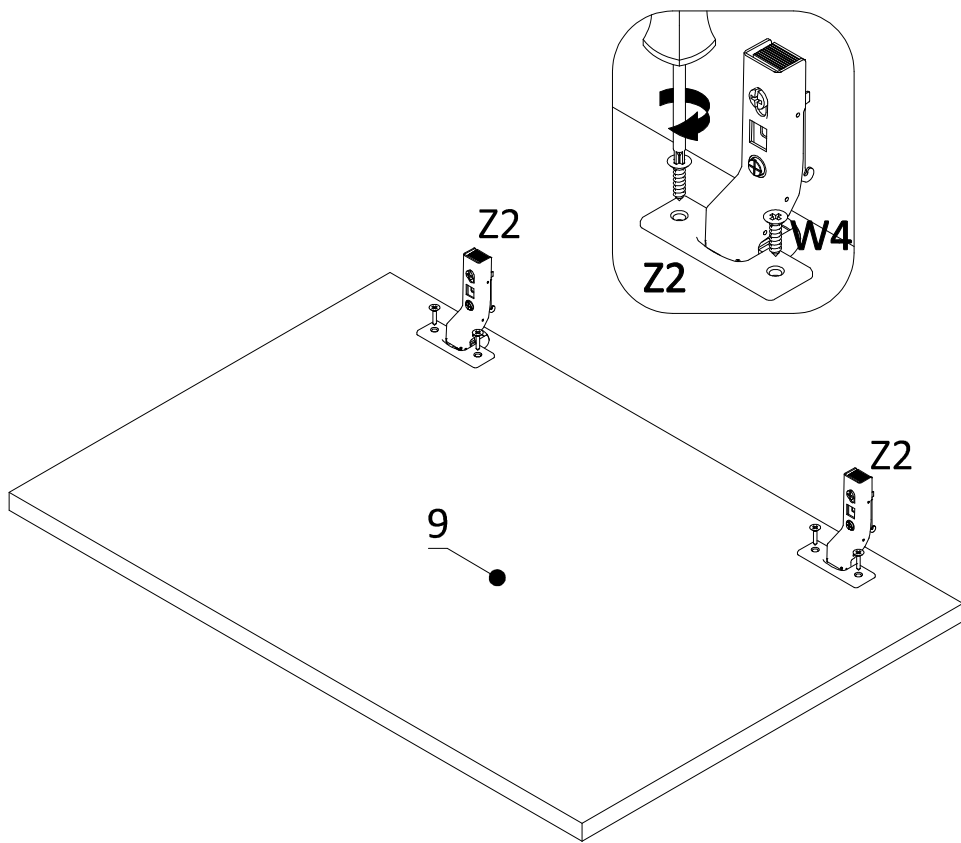

8

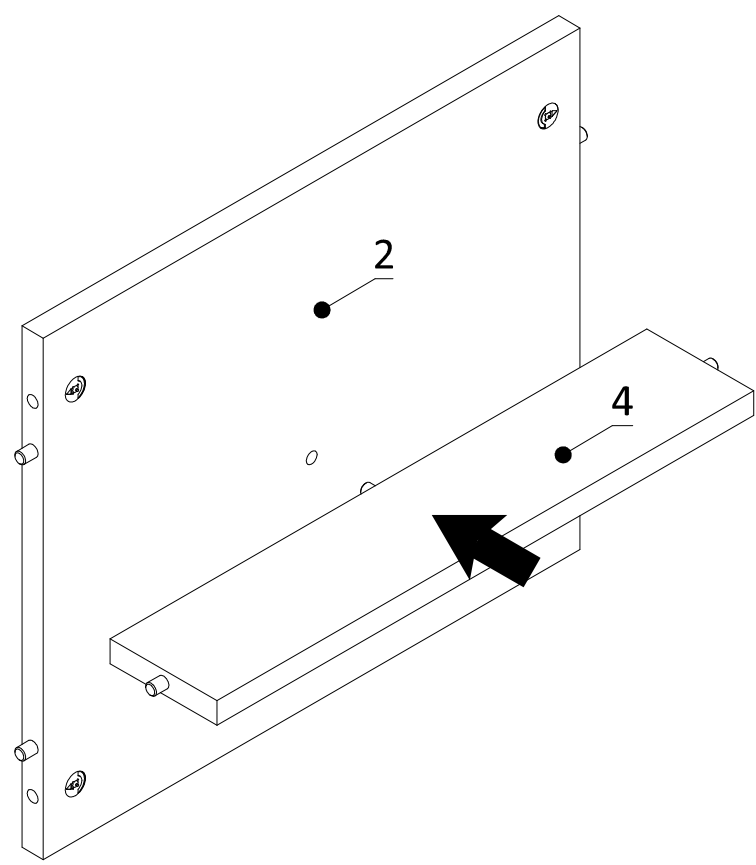

9

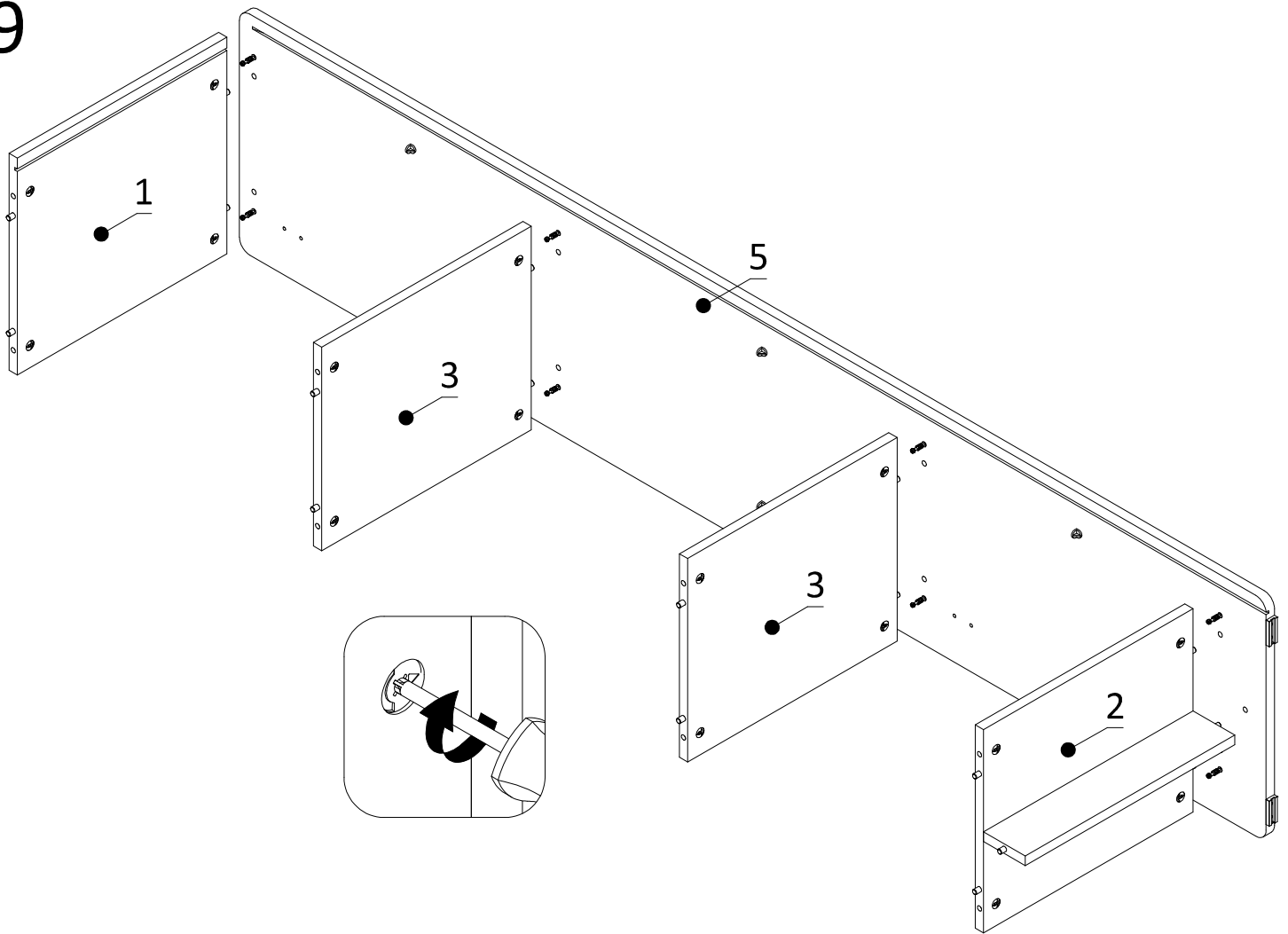

10

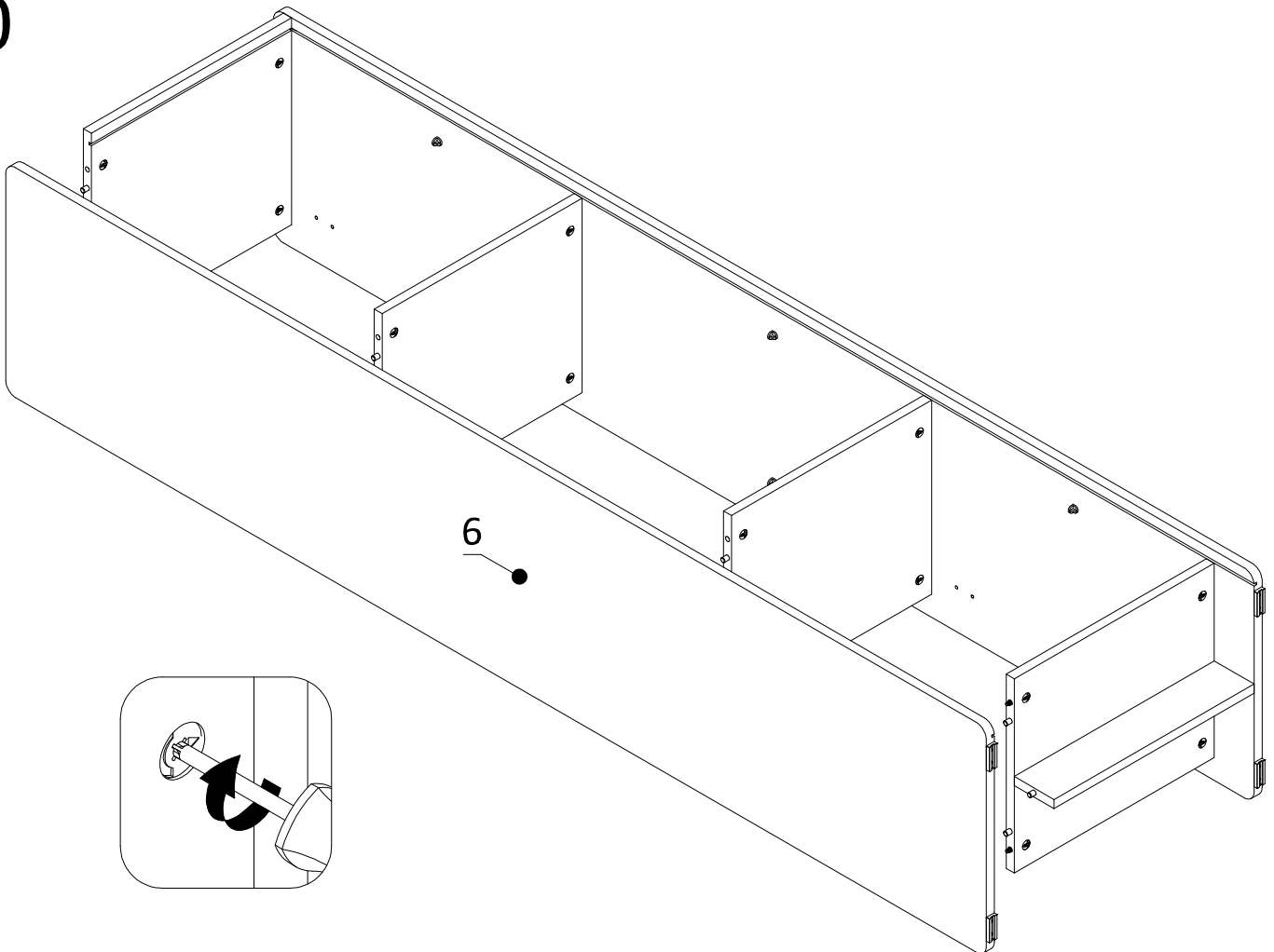

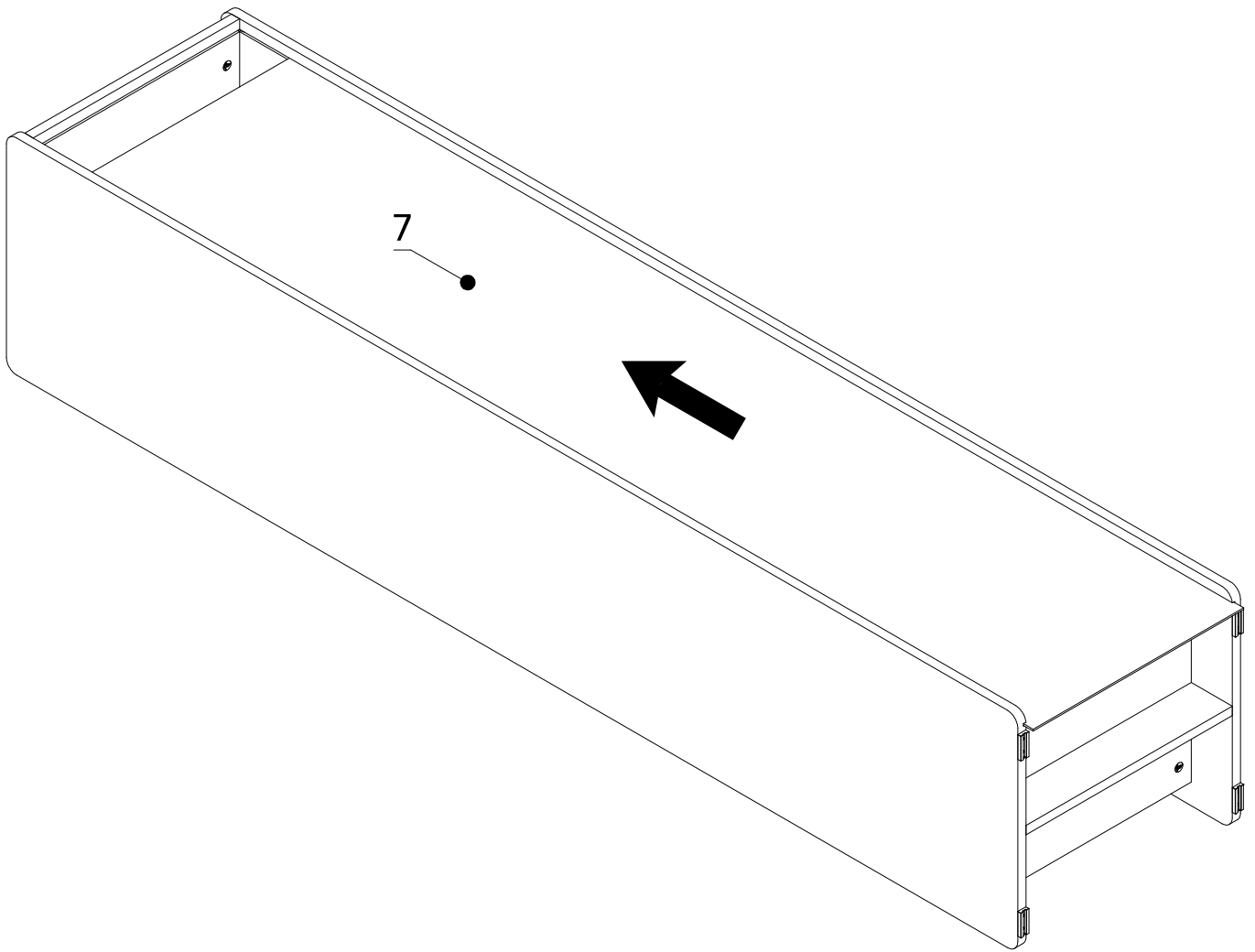

11

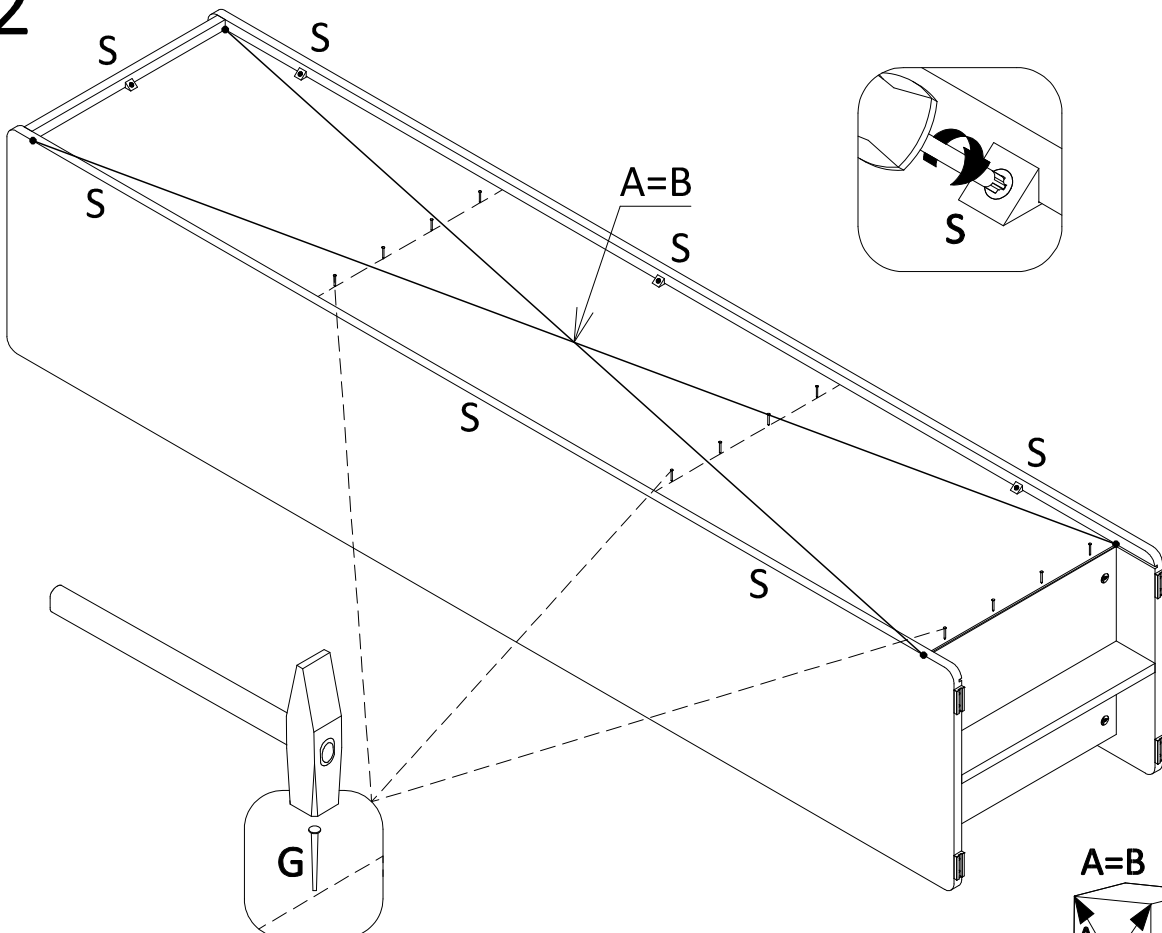

12



	
G	S
12x	7x

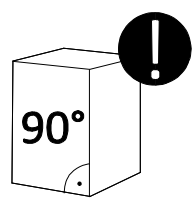
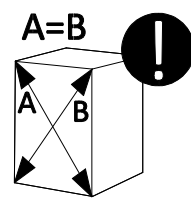
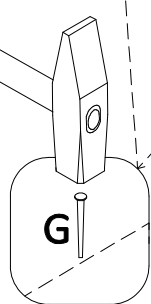
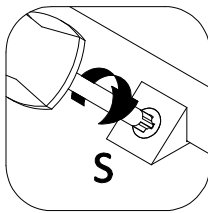

13

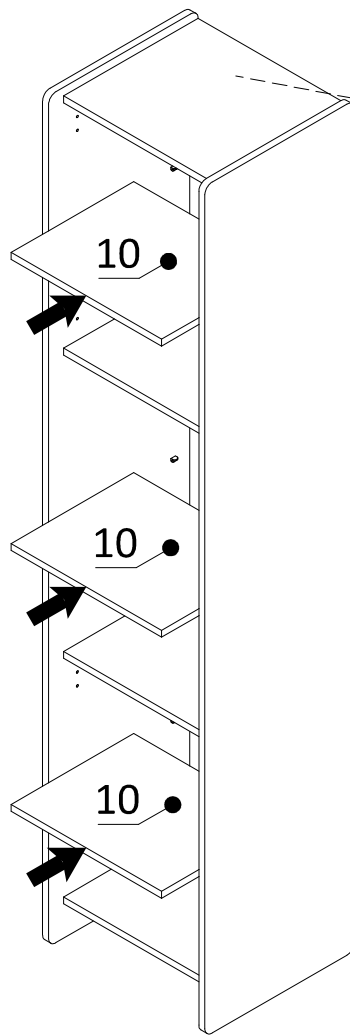
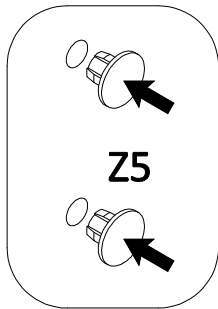
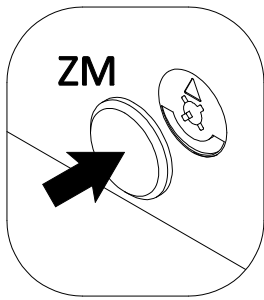

		1x
1		×
2		○
3		PS
4		×

14

